

FloEFD Electronics Cooling Module

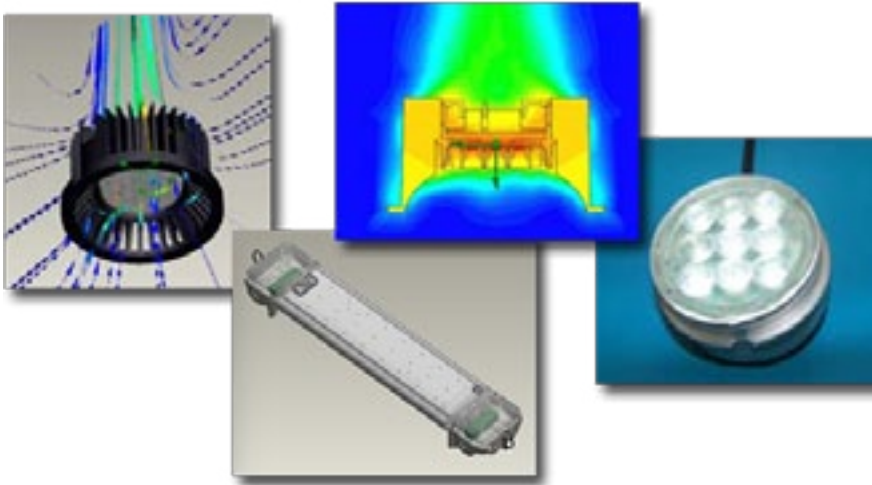

Mentor Graphics' Mechanical Analysis Division has been a leader in the simulation of airflow and temperature for the engineering community since 1989. With FloEFD's concurrent CFD, software that connects directly with your CAD software, users can simulate airflow and heat transfer using 3D CAD models directly, with no need for data translations or copies.

More specifically the Electronics Cooling Module for FloEFD provides additional capabilities for analysis by specialists who support electronics cooling applications. Physical capabilities added to FloEFD are:

Joule Heating

FloEFD is able to calculate steady-state direct electric current in electro-conductive solids:

- The Joule heating effect is automatically calculated and included in heat transfer calculations
- The calculations of electric potential and current are performed only in conductive solids, i.e. metals and metal-containing composite materials
- The electrical resistivity of the material may be isotropic, anisotropic or temperature dependent

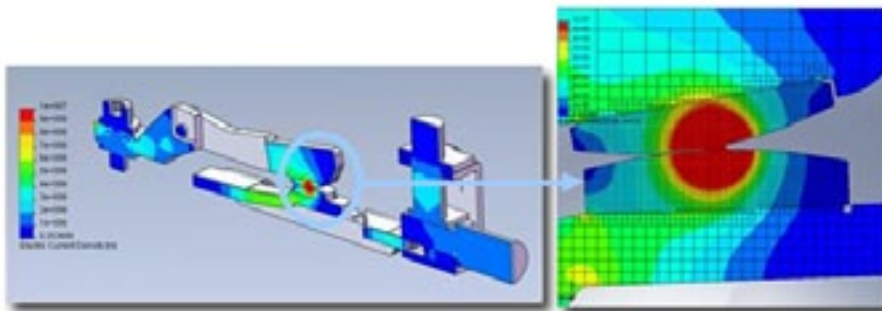

Customer Testimonial:

"Although power LEDs are becoming more efficient, a significant amount of input power translates into heat. Cooling of the electronics and LED devices is critical to long-term reliability and so thermal analysis - including airflow analysis - is vital to help us meet our demanding development schedules...FloEFD is a recognized leader with good support and the software handles all the thermal transfer mechanisms we require."

*Gordon Routledge,
VP of illumination products,
Dialight plc*

"What-if?" Testing Made Easy

One of the most powerful features of FloEFD is the ease with which you can conduct "what-if?" analyses. FloEFD makes it simple to clone/modify your models and analyze design variations. The process is very simple. Create your base model and analyze it. Then create multiple variations of your design by modifying the solid model without having to reapply boundary conditions, material properties etc. When the analysis is complete, FloEFD makes it easy to compare the results among the many options to choose your best possible design. When you are satisfied with your design, publish your report at a touch of a button. You can even publish a fully interactive 3D dynamic plot and share it with colleagues or customers.

Compact Models

To allow for simulation of electronics equipment, the following compact models are offered in this module:

- Two-resistor compact mode
 - Mono-chip electronic packages
 - A defined junction-to-case resistance (R_{jc}) and a junction-to-board (R_{jb}) resistance
 - Two flat solid bodies representing the junction and case
 - They are test-based on an approved JEDEC standard
 - Built-in library of two-resistor models of standard JEDEC package outlines
- Heat pipe compact model
- Printed Circuit Board model including PCB generator (more details below)

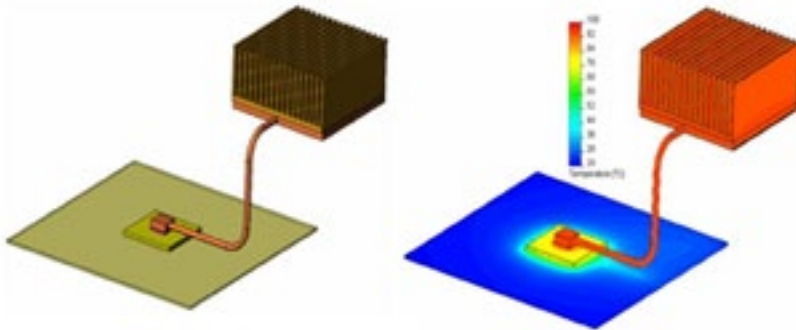

PCB Generator

To obtain the bi-axial thermal conductivity values, the following functionality is also available:

- Normal (through plane) and in-plane thermal conductivities automatically derived from the PCB structure and the properties of the specified conductor and dielectric materials
- The board can also be arbitrarily oriented with respect to the global coordinate system
 - i.e. angled PCB's can be modeled

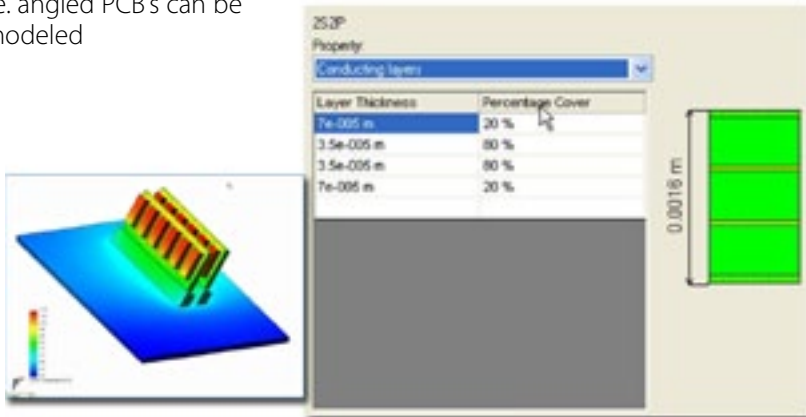

In addition, FloEFD solves the Navier-Stokes equations. FloEFD is capable of predicting both laminar and turbulent flows. FloEFD employs one system of equations to describe both laminar and turbulent flows. Moreover, transition from a laminar to turbulent state and/or vice versa is possible.

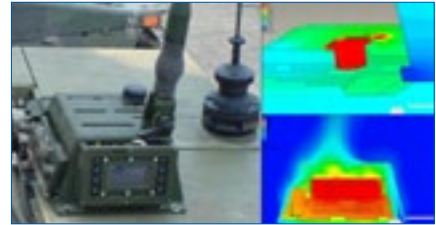

Customer Testimonial:

"FloEFD for Pro/ENGINEER Wildfire's ease of use, speed and accuracy led to its selection over and above the candidates benchmarked. In addition to the technology, I think it is also important to mention the support services, which in the eight years I have been using the software has always been excellent -- both in terms of speed and quality of response."

*Mark Pashley,
Principal Mechanical Engineer,
Thales Air System Division*

Materials Library

In addition to the basic materials, the following are also included in this module:

- More than 1000 fans from different fan manufacturers
- Database of solids materials such as alloys, ceramics, metals, polymers, laminates, glasses and minerals, semiconductors
- Database of IC packages
- Database of single- and multi-stage Thermo-Electric Coolers (TEC)
- Database of interface materials (contact thermal resistance)
- Database of two-resistor components

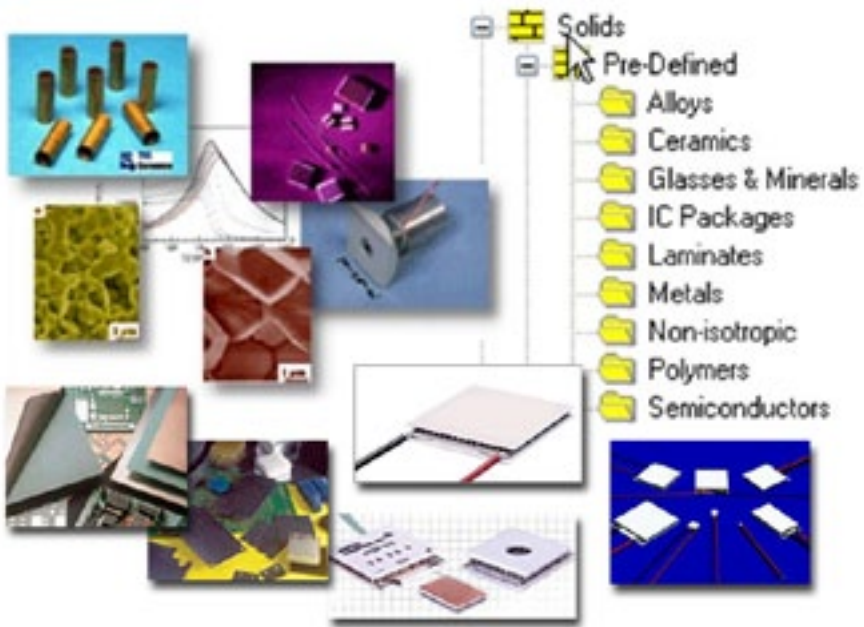

Customer Testimonial:

"FloEFD computational fluid dynamics software enables design engineers without a fluid analysis background to perform thermal simulation. The result is that we got the design right the first time, only had to make one prototype and avoided expensive design changes that typically occur in the late stages of the development process."

James Young, Design Engineer, Azonix

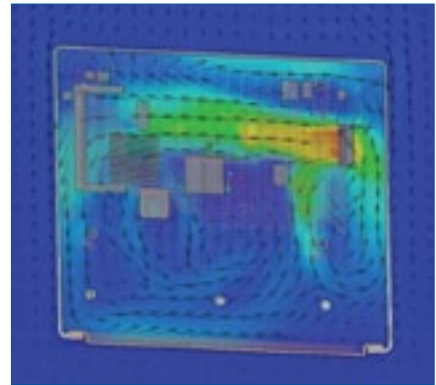

For the latest product information, visit: www.3hti.com

3HTi LLC, Corporate Headquarters

3000 Atrium Way #296
Mt. Laurel, NJ 08054
866-624-3HTi

